

CPDQC5V0USP-HF

RoHS Device

Halogen Free



Features

- Uni-directional ESD protection.
- IEC61000-4-2 Level 4 ESD protection.
- Surface mount package.
- Low capacitance.
- Low Leakage current.
- High component density.

Mechanical data

- Case: 0402C/SOD-923F standard package, molded plastic.
- Terminals: Matte tin plated, solderable per MIL-STD-750, method 2026.
- Marking Code: Cathode band & 5S
- Mounting position: Any.
- Weight: 0.001 gram(approx.).

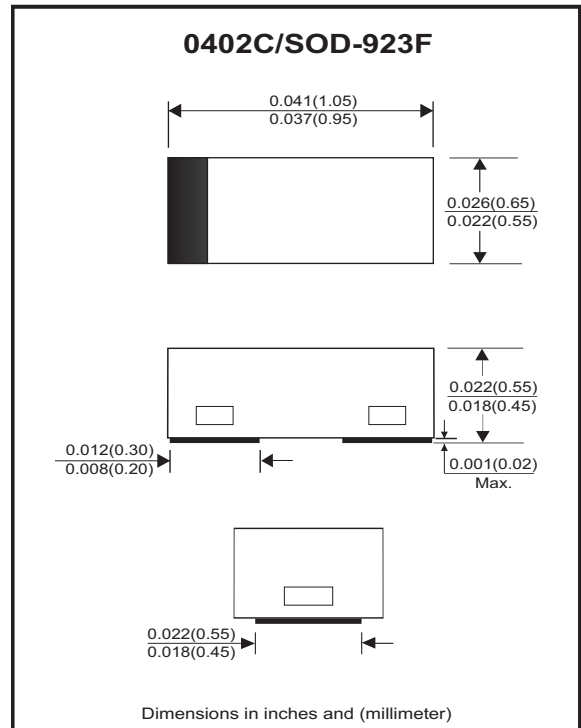

Circuit diagram



Maximum Rating (at TA=25°C unless otherwise noted)

Parameter	Conditions	Symbol	Value	Unit
Peak pulse power	T _P = 8/20us	P _{PP}	50	W
Peak pulse current	T _P = 8/20us	I _{PP}	2.5	A
ESD capability	IEC 61000-4-2(air) IEC 61000-4-2(contact)	ESD	±15 ±8	kV
Operation temperature range		T _J	-55~+150	°C
Storage temperature range		T _{STG}	-55~+150	°C

Electrical Characteristics (at TA=25°C unless otherwise noted)

Parameter	Conditions	Symbol	Min	Typ	Max	Unit
Working peak reverse voltage		V _{RWM}			5	V
Forward voltage	I _F = 10mA	V _F			1.5	V
Diode breakdown voltage	I _T = 1mA	V _{BR}	5.4			V
Reverse current	V _{RWM} = 5V	I _R		0.1	1.0	uA
Clamping voltage	I _{PP} = 1A, T _P = 8/20us I _{PP} = 2.5A, T _P = 8/20us	V _C			13 20	V
Junction capacitance	V _R = 0V, f = 1MHz	C _J		0.6	0.9	pF

Company reserves the right to improve product design , functions and reliability without notice.

REV:B

RATING AND CHARACTERISTIC CURVES (CPDQC5V0USP-HF)

Fig.1 - 8/20us Peak Pulse Current Waveform Acc. IEC 61000-4-5

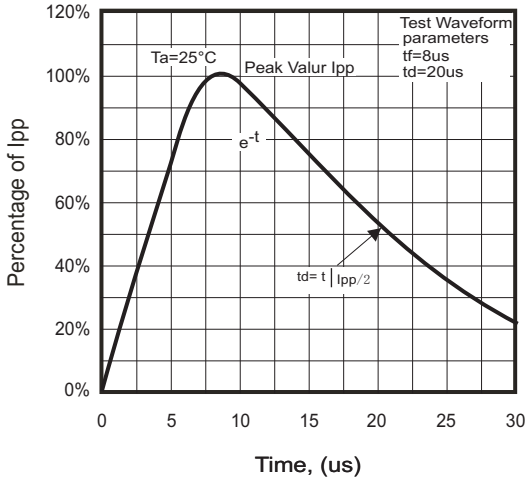

Fig. 2 - Power Rating Derating Curve

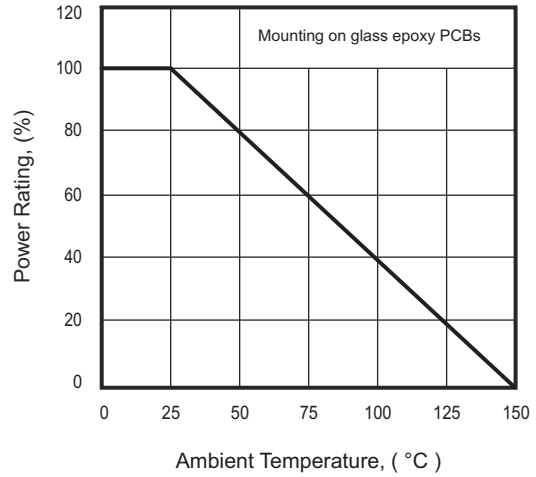

Fig.3 - Clamping Voltage Vs. Peak Pulse Current

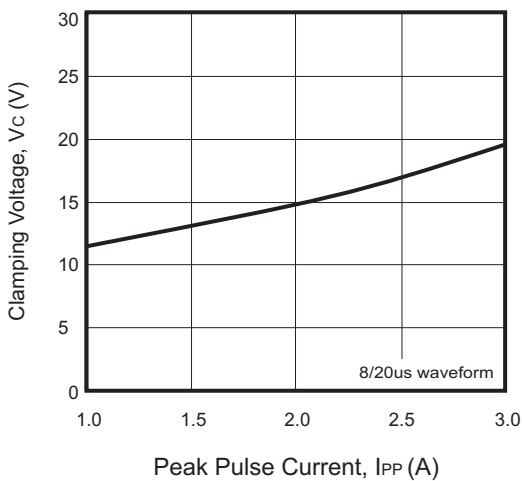

Fig. 4 - Forward Voltage vs. Forward Current

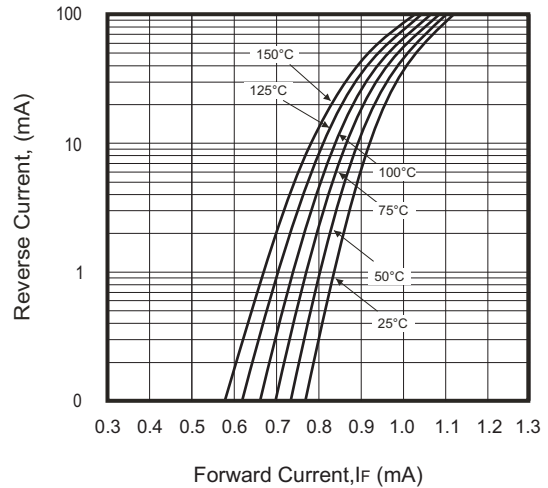
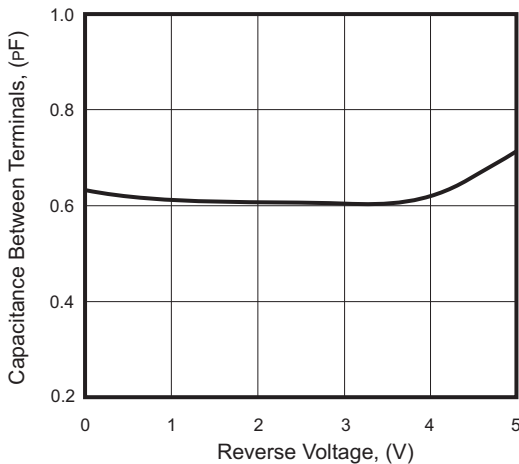
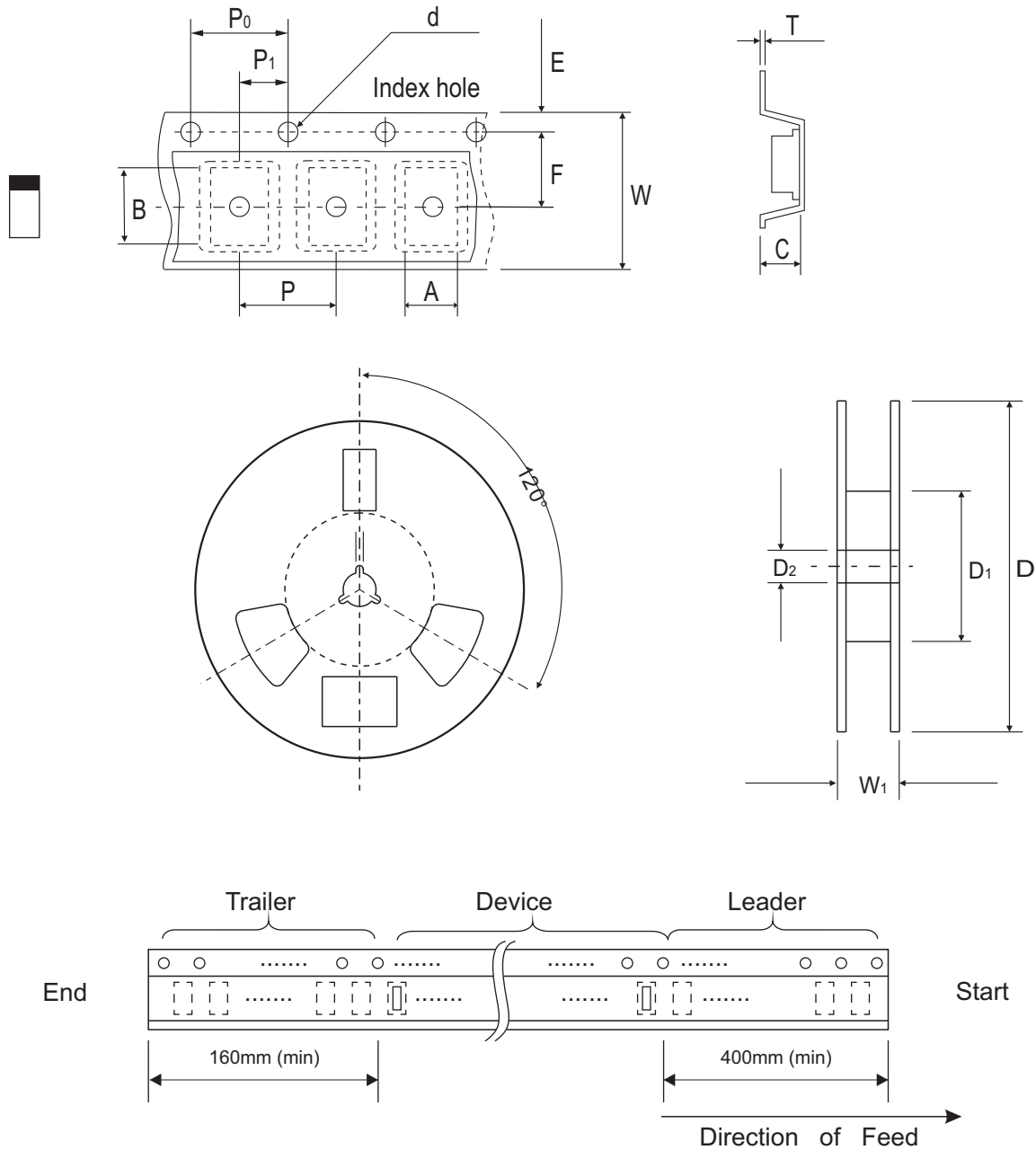

Fig.5 - Capacitance Between Terminals Characteristics



Reel Taping Specification



0402C (SOD-923F)	SYMBOL	A	B	C	d	D	D ₁	D ₂
	(mm)	0.75 ± 0.05	1.17 ± 0.05	0.65 ± 0.05	$1.50 + 0.10$ $- 0$	178.00 ± 1.00	60.00 ± 0.50	13.50 ± 0.20
	(inch)	0.030 ± 0.002	0.046 ± 0.002	0.026 ± 0.002	$0.059 + 0.004$ $- 0$	7.008 ± 0.039	2.362 ± 0.020	0.531 ± 0.008

0402C (SOD-923F)	SYMBOL	E	F	P	P ₀	P ₁	T	W	W ₁
	(mm)	1.75 ± 0.10	3.50 ± 0.10	4.00 ± 0.10	4.00 ± 0.10	2.00 ± 0.10	$0.20 + 0.02$ $- 0.05$	8.00 ± 0.20	$12.00 + 0.50$ $- 0$
	(inch)	0.069 ± 0.004	0.138 ± 0.004	0.157 ± 0.004	0.157 ± 0.004	0.079 ± 0.004	$0.008 + 0.001$ $- 0.002$	0.315 ± 0.008	$0.472 + 0.020$ $- 0$

Company reserves the right to improve product design, functions and reliability without notice.

REV:B

Marking Code

Part Number	Marking Code
CPDQC5V0USP-HF	5S



Suggested PAD Layout

SIZE	0402C/SOD-923F	
	(mm)	(inch)
A	0.70	0.028
B	0.40	0.016
C	0.70	0.028
D	1.10	0.043
E	0.30	0.012

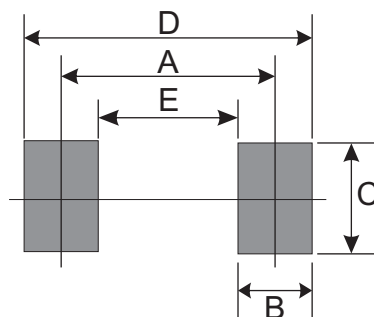

Standard Packaging

Case Type	REEL PACK	
	REEL (pcs)	Reel Size (inch)
0402C/SOD-923F	5,000	7